

Vibration Switches

For 24/7 Protection of Cooling Towers, Fin Fans, HVAC Systems,
Blowers, Motors and Other Critical Machinery

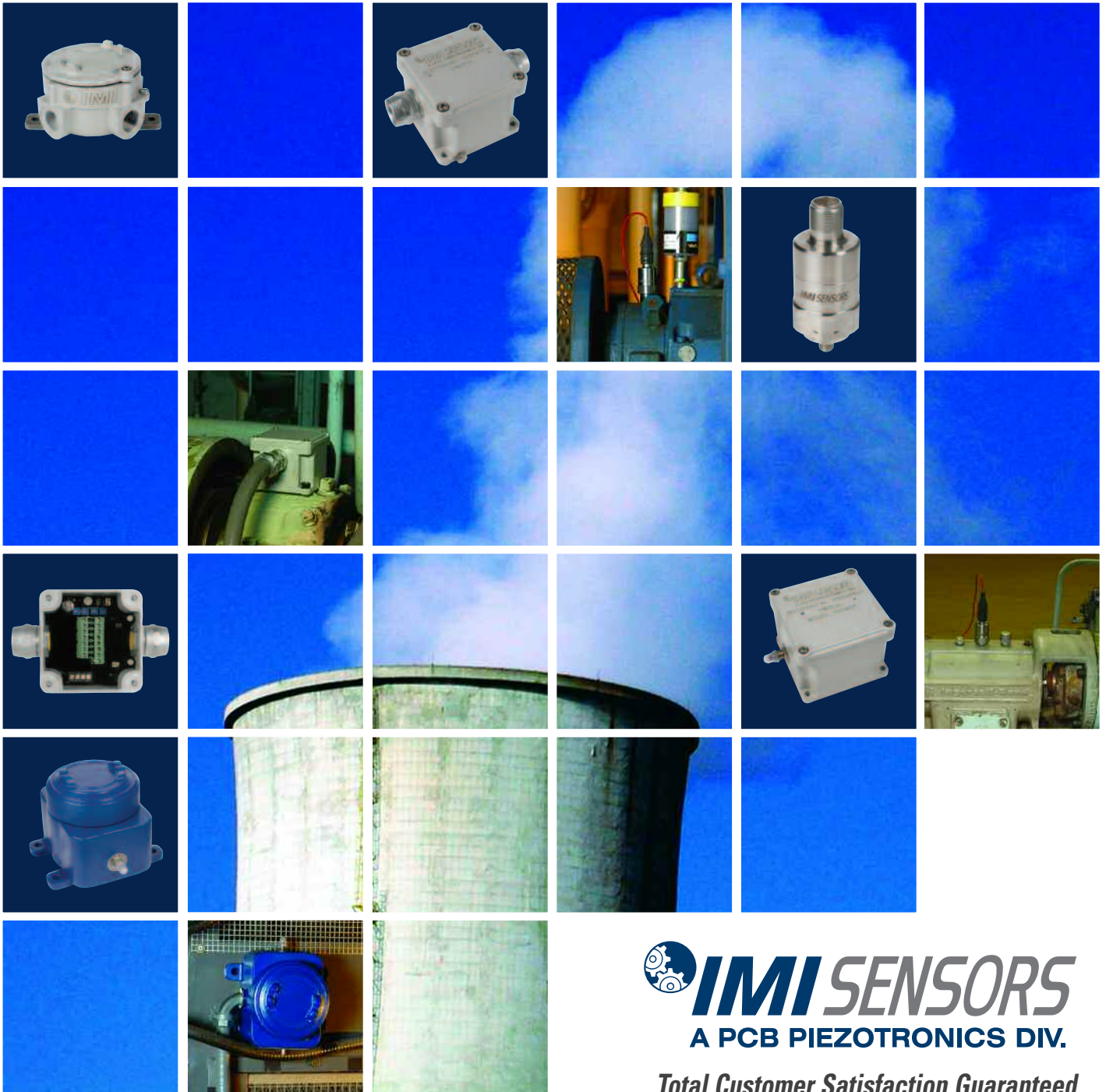

 **IMI SENSORS**
A PCB PIEZOTRONICS DIV.

Total Customer Satisfaction Guaranteed



What is a vibration switch?

A vibration switch is a device that (1) recognizes the amplitude of the vibration to which it is exposed and (2) provides some sort of response when this amplitude exceeds a predetermined threshold value. The switch response is typically an electrical contact closure or contact opening. The electrical contact may be either an electromechanical relay or solid-state triac.

Why use a vibration switch?

Vibration switches are primarily used for protecting critical machinery from costly destructive failure by initiating an alarm or shutdown when excessive vibration of the machinery is detected. Conversely, a vibration switch can be utilized to warn of the absence of vibration, such as when a conveyor ceases to function due to a broken drive belt.

Vibration switches offered by IMI Sensors

Highlighted in this brochure are two common categories of vibration switches – electronic and mechanical. In general, electronic vibration switches offer more precision than mechanical switches.

Electronic switches require power to operate and utilize an input signal that is provided by an electronic vibration sensor, or accelerometer. This sensor may be built into the switch enclosure, or remotely located. A remote sensor is advantageous when the vibration switch enclosure will not fit within the installation location, or if the temperature at the installation location exceeds the capability of the switch's electronic components. The amplitude of the electrical signal

generated by the sensor is proportional to the experienced vibration. Circuitry within the switch compares this signal amplitude against a predetermined threshold value.

Mechanical switches do not require power and utilize the resistive force and travel of a spring as a measure of vibration amplitude. When the travel of a spring exceeds the predetermined threshold, the switch is actuated and latched by magnetic attraction. The threshold value is adjustable by changing the proximity of the magnet to the spring and hence the spring travel required for actuation. Switch reset is accomplished manually by disengaging the magnet from the spring.



Series 685B: Electronic, AC or DC power, dual switches

This precision electronic vibration switch is AC or DC powered, utilizes an on-board or remote accelerometer, provides two relay or triac outputs, generates a 4-20 mA vibration output signal, and offers an analog vibration signal for FFT analysis and fault diagnostics.



Series 686A: Electronic, universal power, single switch

This revolutionary two-wire electronic switch offers the simplicity of a mechanical switch with the precision of an electronic switch. The unit operates from universal power that is scavenged from a load's power source. It is microprocessor controlled, has a built-in accelerometer, installs easily with a single stud, and has the smallest footprint of any vibration switch on the market.



Series 685AX1: Electronic, DC power, single switch

This general-purpose electronic vibration switch is DC powered, utilizes an on-board accelerometer, and offers a single, 5-amp, Form C relay output.





Series 685: Mechanical, single switch

This mechanical vibration switch is available in either in a NEMA 4 (IP66) or explosion proof housing, and offers a single, 5-amp, Form C relay output.



Series 685B Electronic Vibration Switch

- Offers two set points with individual alert and alarm relays
- 4-20 mA output signal for vibration monitoring
- Analog, 100 mV/g output signal for fault diagnostics
- Utilizes built-in or remote vibration sensor
- Choice of AC or DC power
- Adjustable time delay
- Accepts 4-20 mA calibrator input signal for accurate threshold value set-up
- Optional adaptors for retrofitting existing switch installations
- Explosion proof models available (contact factory for details)  

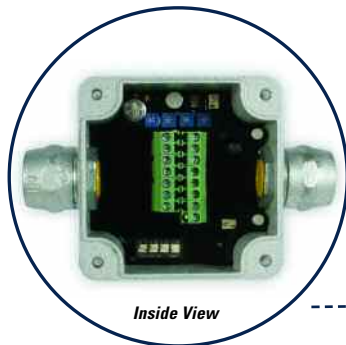

Series 685B



Specifications

Series 685B Performance	English	SI
Measurement Range	see model matrix	
Frequency Range(± 3 dB)	120 to 60k cpm	2 to 1000 Hz
Threshold Set Point (alarm)	10 to 100% FS measurement range	
Threshold Set Point (alert)	10 to 100% of Alarm Set Point	
Relay Time Delay (both relays)	0 to 45 Seconds	
Start-up Delay	20 Seconds	
Relay Action (switch selectable)	latching or non-latching	
Output (Analog Vibration Signal)	100 mV/g	10.2 mV/(m/s ²)
Output (Proportional to Range)	4-20 mA	
Environmental		
Operating Temperature Range	-22 to +158 °F	-30 to +70 °C
Storage Temperature Range	-40 to +257 °F	-40 to +125 °C
Enclosure Rating	NEMA 4X	IP66
Hazardous Area Approval*	Class 1 Div 1 & Class 1 Div 2	
Electrical		
Power Supply Requirement	see model matrix	
Current Draw	< 150 mA	
Integral Sensor Type	piezoelectric accelerometer	
Remote Sensor Option	100 mV/g	10.2 mV/(m/s ²)
Relay Type & Contact Capacity	see model matrix	
Calibration Input Signal	4-20 mA	
Physical		
Size (w x h x d)	3.5 x 2.8 x 3.5 inch	90 x 70 x 90 mm
Weight	1.85 lb	839 gm
Housing Material	aluminum alloy	
Internal Electrical Connectors	screw terminals	
Optional External Analog Connector	BNC jack	
Wire Size for Screw Terminals	24 to 14 AWG	0.2 to 2.5 mm
Enclosure Ports	see model matrix	
Mounting Holes	0.21 inch	5.4 mm
Indicators/Controls		
Power-on LED	green	
Alert LED	yellow	
Alarm LED	red	
Alarm Set Point Adjustment	single turn potentiometer	
Reset Function	internal momentary push button or remote contact closure	
Relay Latch Selection Option	internal slide switch	
Normally Open Normally Closed Option	internal slide switch	
Optional Accessory		
Model 080A209 adaptor plate for retrofit of existing switch installations		

* Hazardous area approval available for some configurations. Contact factory for details.



How to Order

Base Model

685B Electronic Vibration Switch with two set point relays, internal reset pushbutton, remote reset via contact closure, 4-20 mA test/calibration insertion signal capability, and both 4-20 mA and analog 100 mV/g output signals available on screw terminals.

Vibration Sensor Option

- 0 Built-in accelerometer
- 1 No sensor built-in, requires remote, 100 mV/g (10.2 mV/(m/s²)) ICP® accelerometer (not supplied)

Measurement Range

- 0 0 to 1.5 in/sec peak velocity
- 1 0 to 5 g peak acceleration
- 2 0 to 15 mil peak to peak displacement
- 3 0 to 50 mil peak to peak displacement

Power Required

- 0 85 to 245 VAC, 50/60 Hz
- 1 24 VDC ± 10%

Relay Type (two provided)

- 0 Triac, 5 amp, 230 VAC
- 1 Electromechanical Relay 10 amp Form C, SPDT, 30 VDC / 240 VAC

Enclosure Type

- A1 NEMA 4X (IP66) enclosure, with no hazardous area approvals.
- A2 Same as A1 plus external reset pushbutton
- A3 Same as A1 plus external BNC jack for analog vibration signal output
- A4 Same as A1 plus A2 and A3
- C1 CSA approved explosion proof ****must select option 4 below**

Enclosure Connection Ports and Hardware

- 0 Two Ports with Cord Grips
- 1 Two Ports with 1/2 inch NPT Conduit Hubs
- 2 One Port with Cord Grip
- 3 One Port with 1/2 inch NPT Conduit Hub
- 4 Two 1/2 inch NPT ports ****must select C1 above**

Example

685B 0 0 0 0 A1 1 Electronic vibration switch with built-in vibration sensor, 0 to 1.5 in/sec pk velocity measurement range, 85 to 245 VAC powered, two triac relays, and NEMA 4X enclosure with two ports and cord grips.



Series 686A Smart Vibration Switch

- Smallest footprint of any vibration switch
- Offers one set point with solid-state relay
- Utilizes built-in vibration sensor
- Microprocessor controlled
- AC or DC powered
- Magnetically Adjustable Vibration Threshold (MAVT™) automatically sets trip level
- Installs using same mounting technique as conventional vibration sensors
- Connects with industry standard MIL-C-5015 connector or integral cable
- Patent pending
- USB programmable parameters



Series 686A
(actual size)



Specifications

Series 686A		
Performance	English	SI
Measurement Range	see model matrix	
Frequency Range (± 3 dB)	180 to 60k cpm	3 to 1000 Hz
Threshold Range	0.25 to 6.0 ips pk	
Threshold Hysteresis	6%	
Alarm Time Delay (selectable, see matrix)	3 to 12 seconds	
Relay Action (selectable, see matrix)	latching or non-latching	
Start Up Delay (if selected, see matrix)	20 \pm 5 seconds	
Power On Delay (fixed, all versions)	20 \pm 5 seconds	
Transverse Sensitivity	< 3%	
Environmental		
Operating Temperature Range	-40 to +185 °F	-40 to +85 °C
Electrical		
Power Required	24 to 240 VDC or VAC	
Leak Current in Open Condition	1 mA	
Sensor Type	piezoelectric accelerometer	
Relay Type and Contact Capacity	SPST Form A or B, N.O. or N.C. 24 to 240 VAC or VDC @ 0.5 Amp	
Physical		
Housing Material	316 stainless steel	
Sealing	welded hermetic	
Electrical Connectors	see model matrix	
Mounting Thread	1/4-28 female	
Size (hex \times height)	1.25 \times 2.5 inch	63.5 mm
Weight	7 oz	198 gm
Supplied Accessories		
Model 081A40	mounting stud 1/4-28 male to 1/4-28 male	

How to Order

Base Model

686A Smart, two-wire, electronic vibration switch

Threshold Adjustability

- 0 Fixed threshold value - factory set
- 1 Field adjustable threshold value with MAVT™ or USB interface

Threshold Value - Factory Setting

- 00 Field adjustable (unit shipped with factory default setting of 0.6 in/sec)
- 01 0.25 in/sec pk (4.5 mm/sec rms)
- 02 0.4 in/sec pk (7.1 mm/sec rms)
- 03 0.6 in/sec pk (11.2 mm/sec rms)
- 04 1.0 in/sec pk (18.0 mm/sec rms)
- 05 1.6 in/sec pk (28.2 mm/sec rms)
- 06 2.5 in/sec pk (45 mm/sec rms)
- 07 4.0 in/sec pk (71 mm/sec rms)
- 08 6.0 in/sec pk (112 mm/sec rms)

Time Delay for Relay Activation

- 03 3-second delay
- 06 6-second delay
- 09 9-second delay
- 12 12-second delay

Relay Action and Startup Delay

- 1 Non-latching, normally open with 20-second startup delay
- 2 Non-latching, normally closed with 20-second startup delay
- 3 Latching, normally open with 20-second startup delay
- 4 Latching, normally closed with 20-second startup delay
- 5 Non-latching, normally open without startup delay
- 6 Non-latching, normally closed without startup delay
- 7 Latching, normally open without startup delay
- 8 Latching, normally closed without startup delay

Electrical Connector

- 1 2-pin MIL-C-5015
- 2 Integral, 10 ft. polyurethane cable (Model 052)
- 3 Integral, 10 ft. armored polyurethane cable (Model 047)
- 4 Integral, 10 ft. Teflon® cable (Model 053)
- 5 Integrated, 10 ft. armored Teflon® cable (Model 048)

Example

686A 1 00 06 3 1 Smart, two-wire, electronic vibration switch

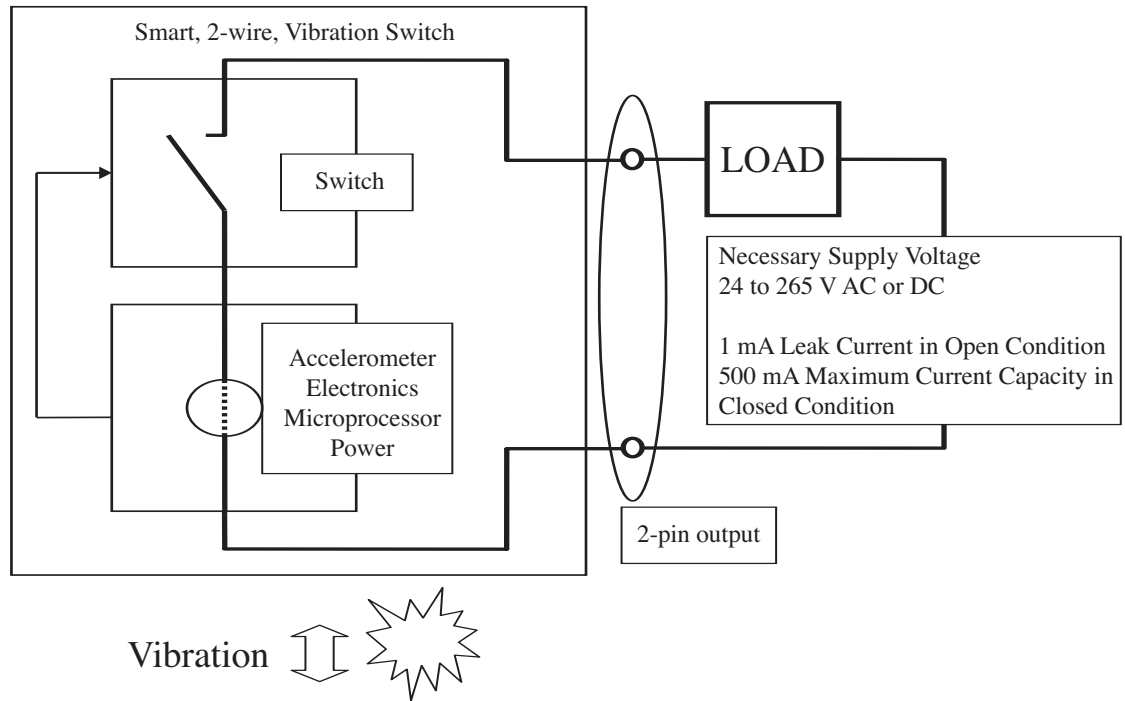

Series 686A Operating Principle

The Series 686A Smart Vibration Switch operates over just two wires. It installs in series with any load, which can be an annunciator, PLC, or relay coil. To energize itself, the vibration switch scavenges power from the load's power source. When a threshold exceedance is encountered, the switch is activated and the load's power circuit is completed to facilitate the desired alarm or shutdown.

Benefits of Solid State Relays

A solid state relay is an electronic component that functions in the same way as an electromechanical relay, but without any moving parts. A solid state relay offers the most reliable switch action, especially for vibration applications where moving relay components run a greater risk of malfunction. They are purely electronic devices composed of a low current control side and a high current load side for switching action.

What is MAVT™?

Magnetically Adjustable Vibration Threshold (MAVT)™ is an optional feature of the Series 686A smart vibration switch that permits the set threshold value to be adjusted at the switch's installation location or in a calibration laboratory. The Series 686A has no accessible mechanical adjustments, such as screw pots, that are found on other style electronic vibration switches, however, when fitted with the MAVT™ option the 686A becomes adjustable through magnetic actuation. By exposing a specified location on the housing to a strong magnetic field, an internal switch is actuated, which initiates a test sequence within the unit's microprocessor. For a 30-second period of time, the unit will measure the vibration amplitude to which it is exposed and then determine the average vibration value (x). This average value is then doubled (2x) and the threshold value is then automatically set to this 2x value. This convenient feature permits any machine to become vibration switch protected within seconds and without hassle. For a more accurate adjustment, the 686A can be mounted to a vibrating shaker to set its threshold value at 2x the known input vibration that is delivered by the shaker.





Series 685AX1 Electronic Vibration Switch

- Utilizes built-in vibration sensor
- Offers one set point with electromechanical relay
- DC powered
- Fixed time delay



Series 685AX1

Specifications

Series 685A		
Performance	English	SI
Measurement Range	see model matrix	
Frequency Range (± 3 dB)	180 to 60k cpm	3 to 1000 Hz
Set Point Adjust (single alarm)	10 to 100% FS	
Alarm Time Delay (fixed)	5 seconds	
Relay Action (switch selectable)	latching or non-latching	
Start Up Delay (fixed)	3 seconds	
Environmental		
Operating Temperature Range	-13 to +158 °F	-25 to +70 °C
Storage Temperature Range	-40 to +257 °F	-40 to +125 °C
Enclosure Rating	NEMA 4X	
Electrical		
Power Required	10 to 30 VDC	
Current Draw	<100 mA	
Sensor Type (built-in)	piezoelectric accelerometer	
Relay Type	electromechanical relay	
Switch Contact Capacity	see model matrix	
Physical		
Housing Material	Aluminum alloy	
Electrical Connections	power, alarm, remote reset	
Electrical Connectors	removable screw terminals	
Wire Size (accommodated by screw terminals)	24 to 14 AWG	0.2 to 2.5 mm ²
Enclosure Ports (2 places)	1/2 inch NPT	
Mounting Holes diameter (2 places)	0.310 inch	7.9 mm
Size (w × h × d)	5.1×3.0×4.0 inch	130 ×76.2×102 mm
Weight	1.4 lb	635 gm
Indicators/Controls		
Power-on LED	green	
Alarm LED	red	
Alarm Set Point Adjustment	single turn potentiometer	
Reset Function	internal momentary push button or remote contact closure	
Latching/Non-latching Selection	slide switch	
NO/NC Select	slide switch	

How to Order

Series

685A Electronic Vibration Switch with one set point relay, internal reset pushbutton, and remote reset via contact closure, 10 to 30 VDC powered.

Version

- 01** 0 to 10 g (98.1 m/s²) pk measurement range.
HI set point with **5 Amp** Form C relay (230 VAC/30 VDC).
 10 g vibration limit for N.O. contact setting, 5 g vibration limit for N.C. contact setting.
- 11** 0 to 1 ips (25.4 mm/s) pk measurement range.
HI set point with **5 Amp** Form C relay (230 VAC/30 VDC).
 10 g vibration limit for N.O. contact setting, 5 g vibration limit for N.C. contact setting.
- 21** 0 to 10 g (98.1 m/s²) pk measurement range.
LO set point with **5 Amp** Form C relay (230 VAC/30 VDC).
 10 g vibration limit for N.O. contact setting, 5 g vibration limit for N.C. contact setting.
- 31** 0 to 1 ips (25.4 mm/s) pk measurement range.
LO set point with **5 Amp** Form C relay (230 VAC/30 VDC).
 10 g vibration limit for N.O. contact setting, 5 g vibration limit for N.C. contact setting.
- 41** 0 to 10 g (98.1 m/s²) pk measurement range.
HI set point with **1 Amp** Form C relay (230 VAC/30 VDC).
 20 g vibration limit for N.O. or N.C. contact setting.
- 51** 0 to 1 ips (25.4 mm/s) pk measurement range.
HI set point with **1 Amp** Form C relay (230 VAC/30 VDC).
 20 g vibration limit for N.O. or N.C. contact setting.
- 61** 0 to 10 g (98.1 m/s²) pk measurement range.
LO set point with **1 Amp** Form C relay (230 VAC/30 VDC).
 20 g vibration limit for N.O. or N.C. contact setting.
- 71** 0 to 1 ips (25.4 mm/s) pk measurement range.
LO set point with **1 Amp** Form C relay (230 VAC/30 VDC).
 20 g vibration limit for N.O. or N.C. contact setting.

Example

685A 01 Electronic vibration switch with 0 to 10 g pk measurement range HI set point relay with 5 Amp, Form C contacts, 10 to 30 VDC powered.

Relay Switch Configurations

Form A contacts are also called N.O. (Normally Open) contacts or make contacts. Form A contacts are based on a SPST switch that is wired in a normally open state.

Form B contacts are also called N.C. (Normally Closed) contacts or break contacts. Form B contacts are based on a SPST switch that is wired in a normally closed state.

Form C contacts are also called changeover contacts or transfer contacts. Form C contacts are based on a SPDT switch that that can be independently wired in either a normally open state or normally closed state by the user. It is also possible to utilize both states simultaneously.

A TRIAC is a bidirectional electronic switch which can conduct current in either direction when it is triggered by either a positive or a negative voltage. The TRIAC can be configured as a Form A or Form B switch, however, it is only suitable for switching AC voltages.

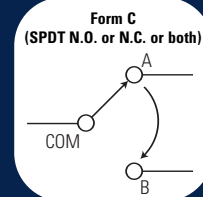
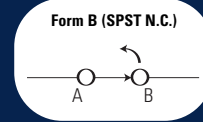
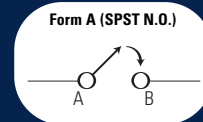



Mechanical Vibration Switches

- Offers cost effective protection for less critical situations
- Utilizes spring-loaded, magnetically coupled sensor
- Provides single set point electromechanical relay
- Requires no power
- Weatherproof and explosion proof versions

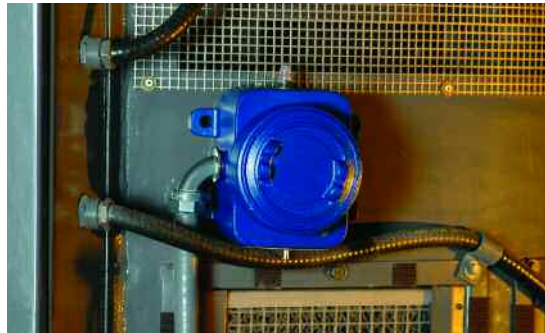

About Mechanical Vibration Switches

For machines requiring simplified contact closure protection, Models 685A07 and 685A08 offer a cost-effective approach to vibration protection. They offer the smallest mechanical switch footprint available in either NEMA 4 or explosion proof housings. The three axis protection allows confident, reliable monitoring of small plant equipment in less critical situations, where the precision of an electronic switch isn't necessarily required. Both the weatherproof and explosion proof versions contain manual internal adjustability with an external reset switch for ease of operation.

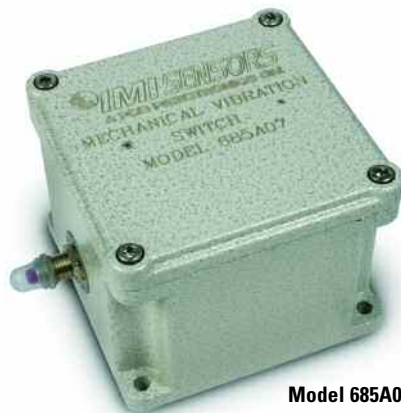

Model 685A07



Model 685A08

Specifications

Models	685A07		685A08	
	English	SI	English	SISI
Performance				
Vibration Range (FS) pk	0 to 7 g	0 to 68.7 m/s ²	0 to 7 g	0 to 68.7 m/s ²
Frequency Range	120 to 60k cpm	0 to 100 Hz	0 to 6000 cpm	0 to 100 Hz
Threshold Set Point (single alarm)	10 to 100% FS		10 to 100% FS	
Relay Action	latching		latching	
Environmental				
Operating Temperature Range	-40 to +140 °F	-40 to +60 °C	-40 to +140 °F	-40 to +60 °C
Enclosure Rating	NEMA 4X	IP66	NEMA 7 explosion proof	
Hazardous Area Approval*	N/A		class 1, div 1, groups C and D	
Electrical				
Power Required	none		none	
Sensor Type (built-in)	spring loaded magnet		spring loaded magnet	
Relay Type	Form C, electromechanical relay		Form C, electromechanical relay	
Switch Contact Capacity	5 Amp, 480 VAC	2 Amp, 30 VDC	5 Amp, 480 VAC	2 Amp, 30 VDC
Physical				
Housing Material	aluminum alloy		aluminum alloy	
Electrical Connections	alarm		alarm	
Electrical Connectors	screw terminals		screw terminals	
Wire Size (screw terminals)	24 to 14 AWG	0.2 to 2.5 mm ²	24 to 14 AWG	0.2 to 2.5 mm ²
Enclosure Ports (1 place)	3/4-14 NPT		3/4-14 NPT	
Mounting Holes (4 places)	0.25 inch	6.4 mm	0.375 inch	10 mm
Size (w × h × d)	4.35×3.30×4.35 inch	110.5×83.8×110.5 mm	6.375×4.875×5.625inch	162×124×143 mm
Weight	2.1 lb	953 gm	5.5 lb	2200 gm
Indicators/Controls				
Alarm Set Point Adjustment	control screw		control screw	
Reset Function	push button switch		push button switch	



Series 682A06 Universal Transmitter

- Provides loop power for two-wire, 4-20 mA sensors and transmitters
- Accepts mA, VDC, RTD, TC, linear resistance, and potentiometer inputs
- Delivers current and voltage output signals
- Offers two set points with Form A relay outputs (2 amp AC, 1 amp DC)
- Fully programmable via detachable pushbutton display (Model 070A80)
- Operates from 19.2 to 300 VDC or 21.5 to 253 VAC power



Model 682A05 Bearing Fault Detector

- Provides early warning of bearing and gear faults
- Detects impacting associated with spalling, cracking, and lubrication problems
- Outputs 4-20 mA signals for peak acceleration and overall vibration
- Operates with PLC, DCS, SCADA, alarm, and control systems
- Offers analog output signal for spectral analysis and diagnostics
- Conducts continuous vibration monitoring — 24/7
- Accepts input from ICP® accelerometers
- Patented technology (US Patent No. 6,889,553)
- Easy to install



Model 682A03 Vibration Transmitter

- Provides ICP® sensor excitation
- Adjustable low-pass and high-pass filtering
- Peak or rms proportional output
- Selectable acceleration, velocity, or displacement output signal
- 24 VDC powered
- Optional 4-20 mA temperature output



Model 699A04 Portable Calibration Shaker

- Fully integrated vibration exciter with adjustability and digital readout
- Choice of acceleration, velocity, or displacement modes
- Variable frequency
- Variable amplitude
- Built-in NIST-traceable reference accelerometer
- 110 to 220 VAC 50 to 60 Hz powered



Model 699A05 Portable 4-20 mA Loop Calibrator

- Provides both transmitter readout and transmitter simulation functionality
- Powers two-wire transmitters and displays transmitter output current
- Simulates a two-wire transmitter and provides output current for testing readout or control devices
- Easy-to-read, high-contrast display
- Pocket sized portability and includes belt clip



3425 Walden Avenue, Depew, NY 14043-2495 USA
IMI Sensors Division toll free 800-959-4464
24-hour SensorLineSM 716-684-0003
Fax 716-684-3823 **E-mail** imi@pcb.com
Web site www.imi-sensors.com

ISO 9001:2000 CERTIFIED

A2LA ACCREDITED to ISO 17025

© 2007 PCB Group, Inc. In the interest of constant product improvement, specifications are subject to change without notice.
 PCB, IMI with associated logo, ICP, Swiveler, and Spindler are registered trademarks of PCB Group, Inc.
 MAVT is a trademark of PCB Group, Inc. SensorLine is a service mark of PCB Group, Inc.
 All other trademarks are properties of their respective owners.

The IMI Sensors Division of PCB® Piezotronics, Inc. specializes in the development, application, and support of industrial vibration sensors, transmitters, meters, and accessories for machinery condition monitoring and predictive maintenance requirements. This product focus, coupled with the strengths and resources of PCB®, permits the IMI Sensors division to offer exceptional customer service, 24-hour technical assistance, and a **Total Customer Satisfaction** guarantee.

Visit www.imi-sensors.com to locate your nearest sales office